

PROJECT	_____
TYPE	_____
SPECIFIER	_____
QUANTITY	_____
DATE	_____

## BIONIQ ROUND ADJUSTABLE RECESSED

**A35224-** \_\_\_\_\_

base number    Color \_\_\_\_\_    Finishes \_\_\_\_\_  
 Temperature    (Diamond)

- To build a product code in our configurator select the specify button on the base model # product page
- To build a manual product code on this datasheet choose from the options listed below in blue font and add the suffix to the base model #

### GENERAL

Series: Bioniq  
 Subseries: Bioniq Round Adjustable  
 Brand: Prolicht  
 Division: Architectural  
 Mounting Type: Recessed  
 Mounting Location: Ceiling  
 Subcategory: Downlight

### PHYSICAL

Shape: Round  
 Diameter (mm): 107  
 Diameter (in): 4 3/16  
 Height (mm): 112  
 Height (in): 4 7/16  
 Ceiling Thickness (mm): 10 / 12.5 / 15  
 Ceiling Thickness (in): 3/8 or 1/2 or 9/16  
 Min. Recessing Depth (mm): 130  
 Min. Recessing Depth (in): 5 1/8  
 Light Distribution: Adjustable / Downlight  
 Weight (kg): 0.47  
 Weight (lbs): 1.04  
 Fixture Finish: SSR / BKV / CWI / CRY / HAB / UFT / ITA / RUA / FTG / MYG / LOD / PUS / FRO / FUP / KIA / POP / BLS / SPG / MEY / GOH / GUM / CHC / COM / ABZ / JAG / OBR / MOS / ROR  
 Fixture Material: Aluminum Die Cast  
 Cut-out Measurements: 98mm / 3 7/8"

### ELECTRICAL

Lamp Type: LED (Zhaga Standard)  
 Input Wattage (W): 13.2 / 16.5  
 Total Output Wattage (W): 12 / 15  
 Dimming: Tri-Mode (Non-Dimming and Phase Dimming (120Vac only) and 0-10V Dimming)  
 Driver Included: No  
 Driver Location: Recessed Housing  
 Driver Type: Constant Current - Universal  
 Driver Class: Class 2  
 Housing: See components  
 Input Voltage (V): 120 - 277  
 Constant Current (MA): 350

### LED

Number of LEDs: 1  
 Color Temperature (°K): 2700 / 3000 / 3500 / 4000  
 Max. Delivered Lumen (lm): 850 / 950 / 1019 / 1040  
 Nominal Lumen (lm): 960 / 1070 / 1156 / 1180  
 CRI: >90 CRI  
 Efficiency (%): 0.885  
 Lamp Life (hrs): 50000

### OPTICAL

Reflector°: 10  
 Adjustability: Rotational 355°; Tilt 30°

### RATINGS AND CERTIFICATIONS

Certified By: Certified for North American Standards  
 IP rating: IP20



	98mm 3 7/8"	130mm 5 1/8"	10   15mm 3/8"   9/16"	30°	355°	

## BIONIQ ROUND ADJUSTABLE RECESSED

A35224-

PROJECT	_____
TYPE	_____
SPECIFIER	_____
QUANTITY	_____
DATE	_____



PROJECT
TYPE
SPECIFIER
QUANTITY
DATE

## BIONIQ ROUND ADJUSTABLE RECESSED

### A35227-

base number	Color Temperature	Finishes (Diamond)	Reflector Options	Lens Options
-------------	----------------------	-----------------------	----------------------	-----------------

- To build a product code in our configurator select the specify button on the base model # product page
- To build a manual product code on this datasheet choose from the options listed below in blue font and add the suffix to the base model #

#### GENERAL

Series: Bioniq  
 Subseries: Bioniq Round Adjustable  
 Brand: Prolicht  
 Division: Architectural  
 Mounting Type: Recessed  
 Mounting Location: Ceiling  
 Subcategory: Downlight

#### PHYSICAL

Shape: Round  
 Diameter (mm): 107  
 Diameter (in): 4 3/16  
 Height (mm): 112  
 Height (in): 4 7/16  
 Ceiling Thickness (mm): 10 / 12.5 / 15  
 Ceiling Thickness (in): 3/8 or 1/2 or 9/16  
 Min. Recessing Depth (mm): 130  
 Min. Recessing Depth (in): 5 1/8  
 Light Distribution: Adjustable / Downlight  
 Weight (kg): 0.46  
 Weight (lbs): 1.01  
 Fixture Finish: SSR / BKV / CWI / CRY / HAB / UFT / ITA / RUA / FTG / MYG / LOD / PUS / FRO / FUP / KIA / POP / BLS / SPG / MEY / GOH / GUM / CHC / COM / ABZ / JAG / OBR / MOS / ROR  
 Fixture Material: Aluminum Die Cast  
 Cut-out Measurements: 98mm / 3 7/8"

#### ELECTRICAL

Lamp Type: LED (Zhaga Standard)  
 Input Wattage (W): 16.5  
 Total Output Wattage (W): 14  
 Dimming: Tri-Mode (Non-Dimming and Phase Dimming (120Vac only) and 0-10V Dimming)  
 Driver Included: No  
 Driver Location: Recessed Housing  
 Driver Type: Constant Current - Universal  
 Driver Class: Class 2  
 Housing: See components  
 Input Voltage (V): 120 - 277  
 Constant Current (MA): 500

#### LED

Number of LEDs: 1  
 Color Temperature (°K): 2700 / 3000 / 3500 / 4000  
 Max. Delivered Lumen (lm): 930 / 960 / 1009 / 1030  
 Nominal Lumen (lm): 1386 / 1438 / 1511 / 1542  
 CRI: >90 CRI  
 Lamp Life (hrs): 50000

#### OPTICAL

Reflector: 20 / 40 / 60  
 Adjustability: Rotational 355°, Tilt 30°

#### RATINGS AND CERTIFICATIONS

Certified By: Certified for North American Standards  
 IP rating: IP20



## BIONIQ ROUND ADJUSTABLE RECESSED

A35227-

PROJECT \_\_\_\_\_

TYPE \_\_\_\_\_

SPECIFIER \_\_\_\_\_

QUANTITY \_\_\_\_\_

DATE \_\_\_\_\_



PROJECT	
TYPE	
SPECIFIER	
QUANTITY	
DATE	

## BIONIQ ROUND ADJUSTABLE RECESSED

### A35236-

base number    Color    Finishes  
 Temperature    (Diamond)

- To build a product code in our configurator select the specify button on the base model # product page
- To build a manual product code on this datasheet choose from the options listed below in blue font and add the suffix to the base model #

#### GENERAL

Series: Bioniq  
 Subseries: Bioniq Round Adjustable  
 Brand: Prolicht  
 Division: Architectural  
 Mounting Type: Recessed  
 Mounting Location: Ceiling  
 Subcategory: Downlight

#### PHYSICAL

Shape: Round  
 Diameter (mm): 107  
 Diameter (in): 4 3/16  
 Height (mm): 112  
 Height (in): 4 7/16  
 Ceiling Thickness (mm): 10 / 12.5 / 15  
 Ceiling Thickness (in): 3/8 or 1/2 or 9/16  
 Min. Recessing Depth (mm): 130  
 Min. Recessing Depth (in): 5 1/8  
 Light Distribution: Adjustable / Downlight  
 Weight (kg): 0.47  
 Weight (lbs): 1.04  
 Fixture Finish: SSR / BKV / CWI / CRY / HAB / UFT / ITA / RUA / FTG / MYG / LOD / PUS / FRO / FUP / KIA / POP / BLS / SPG / MEY / GOH / GUM / CHC / COM / ABZ / JAG / OBR / MOS / ROR  
 Fixture Material: Aluminum Die Cast  
 Cut-out Measurements: 98mm / 3 7/8"

#### ELECTRICAL

Lamp Type: LED (Zhaga Standard)  
 Input Wattage (W): 13.2 / 16.5  
 Total Output Wattage (W): 12 / 15  
 Dimming: Tri-Mode (Non-Dimming and Phase Dimming (120Vac only) and 0-10V Dimming)  
 Driver Included: No  
 Driver Location: Recessed Housing  
 Driver Type: Constant Current - Universal  
 Driver Class: Class 2  
 Housing: See components  
 Input Voltage (V): 120 - 277  
 Constant Current (MA): 350

#### LED

Number of LEDs: 1  
 Color Temperature (°K): 2700 / 3000 / 3500 / 4000  
 Max. Delivered Lumen (lm): 790 / 880 / 951 / 970  
 Nominal Lumen (lm): 960 / 1070 / 1156 / 1180  
 CRI: >90 CRI  
 Efficiency (%): 0.885  
 Lamp Life (hrs): 50000

#### OPTICAL

Reflector°: 10  
 Optic°: Lens Pack - No Lens  
 Adjustability: Rotational 355°; Tilt 30°

#### RATINGS AND CERTIFICATIONS

Certified By: Certified for North American Standards  
 IP rating: IP20

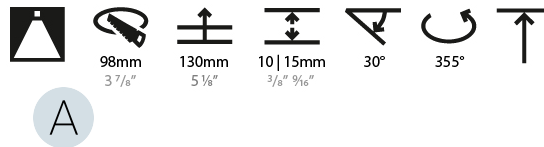

## BIONIQ ROUND ADJUSTABLE RECESSED

A35236-

PROJECT

TYPE

SPECIFIER

QUANTITY

DATE



PROJECT	_____
TYPE	_____
SPECIFIER	_____
QUANTITY	_____
DATE	_____

## BIONIQ ROUND SEMI ADJUSTABLE RECESSED

### A35290-

base number    Color \_\_\_\_\_    Finishes \_\_\_\_\_  
 Temperature    (Diamond)

- To build a product code in our configurator select the specify button on the base model # product page
- To build a manual product code on this datasheet choose from the options listed below in blue font and add the suffix to the base model #

#### GENERAL

Series: Bioniq  
 Subseries: Bioniq Round Semi Adjustable  
 Brand: Prolicht  
 Division: Architectural  
 Mounting Type: Recessed  
 Mounting Location: Ceiling  
 Subcategory: Downlight

#### PHYSICAL

Shape: Round  
 Diameter (mm): 107  
 Diameter (in): 4 3/16  
 Height (mm): 112  
 Height (in): 4 7/16  
 Ceiling Thickness (mm): 10 / 12.5 / 15  
 Ceiling Thickness (in): 3/8 or 1/2 or 9/16  
 Min. Recessing Depth (mm): 130  
 Min. Recessing Depth (in): 5 1/8  
 Light Distribution: Adjustable / Downlight  
 Weight (kg): 0.488  
 Weight (lbs): 1.08  
 Fixture Finish: SSR / BKV / CWI / CRY / HAB / UFT / ITA / RUA / FTG / MYG / LOD / PUS / FRO / FUP / KIA / POP / BLS / SPG / MEY / GOH / GUM / CHC / COM / ABZ / JAG / OBR / MOS / ROR  
 Fixture Material: Aluminum Die Cast  
 Cut-out Measurements: 98mm / 3 7/8"

#### ELECTRICAL

Lamp Type: LED (Zhaga Standard)  
 Input Wattage (W): 13.2 / 16.5  
 Total Output Wattage (W): 12 / 14  
 Dimming: Tri-Mode (Non-Dimming and Phase Dimming (120Vac only) and 0-10V Dimming)  
 Driver Included: No  
 Driver Location: Recessed Housing  
 Driver Type: Constant Current - Universal  
 Driver Class: Class 2  
 Housing: See components  
 Input Voltage (V): 120 - 277  
 Constant Current (MA): 350

#### LED

Number of LEDs: 1  
 Color Temperature (°K): 2700 / 3000 / 3500 / 4000  
 Max. Delivered Lumen (lm): 850 / 950 / 1029 / 1050  
 Nominal Lumen (lm): 960 / 1070 / 1156 / 1180  
 CRI: >90 CRI  
 Efficiency (%): 0.885  
 Lamp Life (hrs): 50000

#### OPTICAL

Reflector°: 10  
 Adjustability: Rotational 355°; Tilt 10°

#### RATINGS AND CERTIFICATIONS

Certified By: Certified for North American Standards  
 IP rating: IP20



112mm 4 7/16"

Ø 95mm 3 3/4"

Ø 107mm 4 3/16"

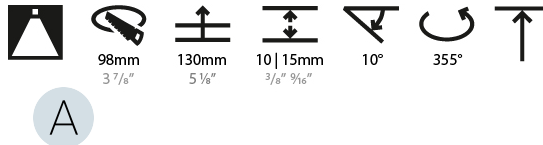

## BIONIQ ROUND SEMI ADJUSTABLE RECESSED

A35290-

PROJECT \_\_\_\_\_

TYPE \_\_\_\_\_

SPECIFIER \_\_\_\_\_

QUANTITY \_\_\_\_\_

DATE \_\_\_\_\_



A



PROJECT	_____
TYPE	_____
SPECIFIER	_____
QUANTITY	_____
DATE	_____

## BIONIQ ROUND SEMI ADJUSTABLE RECESSED

### A35293-

base number	Color	Finishes	Reflector
	Temperature	(Diamond)	Options

- To build a product code in our configurator select the specify button on the base model # product page
- To build a manual product code on this datasheet choose from the options listed below in blue font and add the suffix to the base model #

#### GENERAL

Series: Bioniq
Subseries: Bioniq Round Semi Adjustable
Brand: Prolicht
Division: Architectural
Mounting Type: Recessed
Mounting Location: Ceiling
Subcategory: Downlight

#### PHYSICAL

Shape: Round
Diameter (mm): 107
Diameter (in): 4 3/16
Height (mm): 112
Height (in): 4 7/16
Ceiling Thickness (mm): 10 / 12.5 / 15
Ceiling Thickness (in): 3/8 or 1/2 or 9/16
Min. Recessing Depth (mm): 130
Min. Recessing Depth (in): 5 1/8
Light Distribution: Adjustable / Downlight
Weight (kg): 0.485
Weight (lbs): 1.07
Fixture Finish: SSR / BKV / CWI / CRY / HAB / UFT / ITA / RUA / FTG / MYG / LOD / PUS / FRO / FUP / KIA / POP / BLS / SPG / MEY / GOH / GUM / CHC / COM / ABZ / JAG / OBR / MOS / ROR
Fixture Material: Aluminum Die Cast
Cut-out Measurements: 98mm / 3 7/8"

#### ELECTRICAL

Lamp Type: LED (Zhaga Standard)
Input Wattage (W): 15.5
Total Output Wattage (W): 13
Dimming: Tri-Mode (Non-Dimming and Phase Dimming (120Vac only) and 0-10V Dimming)
Driver Included: No
Driver Location: Recessed Housing
Driver Type: Constant Current - Universal
Driver Class: Class 2
Housing: See components
Input Voltage (V): 120 - 277
Constant Current (MA): 500

#### LED

Number of LEDs: 1
Color Temperature (°K): 2700 / 3000 / 3500 / 4000
Max. Delivered Lumen (lm): 940 / 980 / 1029 / 1050
Nominal Lumen (lm): 1386 / 1438 / 1511 / 1542
CRI: >90 CRI
Lamp Life (hrs): 50000

#### OPTICAL

Reflector: 20 / 40 / 60
Adjustability: Rotational 355°, Tilt 10°

#### RATINGS AND CERTIFICATIONS

Certified By: Certified for North American Standards
IP rating: IP20



## BIONIQ ROUND SEMI ADJUSTABLE RECESSED

A35293-

PROJECT

TYPE

SPECIFIER

QUANTITY

DATE



## BIONIQ ROUND WALLWASH RECESSED

### A35338-

base number    Color    Finishes    Reflector  
 Temperature    (Diamond)    Options

- To build a product code in our configurator select the specify button on the base model # product page
- To build a manual product code on this datasheet choose from the options listed below in blue font and add the suffix to the base model #

#### GENERAL

Series: Bioniq  
 Subseries: Bioniq Round Wallwash  
 Brand: Prolicht  
 Division: Architectural  
 Mounting Type: Recessed  
 Mounting Location: Ceiling  
 Subcategory: Wallwash

#### PHYSICAL

Shape: Round  
 Diameter (mm): 107  
 Diameter (in): 4 3/16  
 Height (mm): 118  
 Height (in): 4 5/8  
 Ceiling Thickness (mm): 10 / 12.5 / 15  
 Ceiling Thickness (in): 3/8 or 1/2 or 9/16  
 Min. Recessing Depth (mm): 140  
 Min. Recessing Depth (in): 5 1/2  
 Light Distribution: Adjustable / Asymmetric  
 Weight (kg): 0.473  
 Weight (lbs): 1.04  
 Fixture Finish: SSR / BKV / CWI / CRY / HAB / UFT / ITA / RUA / FTG / MYG / LOD / PUS / FRO / FUP / KIA / POP / BLS / SPG / MEY / GOH / GUM / CHC / COM / ABZ / JAG / OBR / MOS / ROR  
 Fixture Material: Aluminum Die Cast  
 Cut-out Measurements: 98mm / 3 7/8"

#### ELECTRICAL

Lamp Type: LED (Zhaga Standard)  
 Input Wattage (W): 16.5  
 Total Output Wattage (W): 14  
 Dimming: Tri-Mode (Non-Dimming and Phase Dimming (120Vac only) and 0-10V Dimming)  
 Driver Included: No  
 Driver Location: Recessed Housing  
 Driver Type: Constant Current - Universal  
 Driver Class: Class 2  
 Housing: See components  
 Input Voltage (V): 120 - 277  
 Constant Current (MA): 350

#### LED

Number of LEDs: 1  
 Color Temperature (°K): 2700 / 3000 / 3500 / 4000  
 Max. Delivered Lumen (lm): 1030 / 1070 / 1117 / 1140  
 Nominal Lumen (lm): 1386 / 1438 / 1511 / 1542  
 CRI: >90 CRI  
 Lamp Life (hrs): 50000

#### OPTICAL

Reflector: 20 / 40 / 60  
 Adjustability: Fixed

#### RATINGS AND CERTIFICATIONS

Certified By: Certified for North American Standards  
 IP rating: IP20

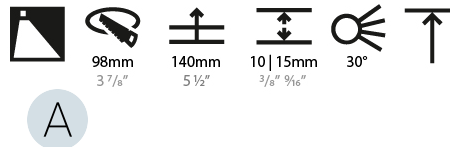
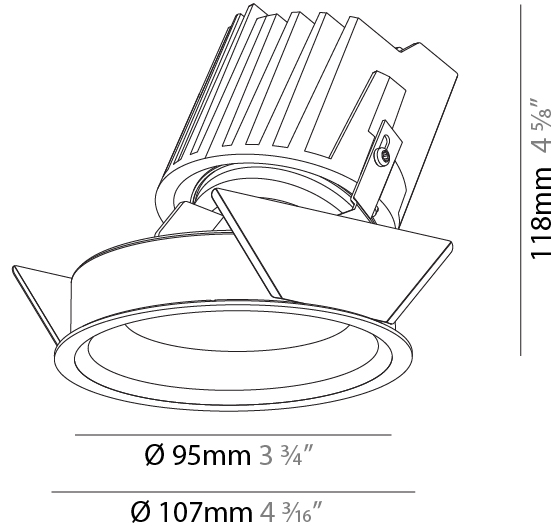

## BIONIQ ROUND WALLWASH RECESSED

A35338-

PROJECT

TYPE

SPECIFIER

QUANTITY

DATE



PROJECT	_____
TYPE	_____
SPECIFIER	_____
QUANTITY	_____
DATE	_____

## BIONIQ ROUND WALLWASH RECESSED

**A35347-** \_\_\_\_\_ - \_\_\_\_\_

base number    Color \_\_\_\_\_    Reflector \_\_\_\_\_  
 Temperature    Options

- To build a product code in our configurator select the specify button on the base model # product page
- To build a manual product code on this datasheet choose from the options listed below in blue font and add the suffix to the base model #

### GENERAL

Series: Bioniq  
 Subseries: Bioniq Round Wallwash  
 Brand: Prolicht  
 Division: Architectural  
 Mounting Type: Recessed  
 Mounting Location: Ceiling  
 Subcategory: Wallwash

### PHYSICAL

Shape: Round  
 Diameter (mm): 107  
 Diameter (in): 4 3/16  
 Height (mm): 118  
 Height (in): 4 5/8  
 Ceiling Thickness (mm): 10 / 12.5 / 15  
 Ceiling Thickness (in): 3/8 or 1/2 or 9/16  
 Min. Recessing Depth (mm): 140  
 Min. Recessing Depth (in): 5 1/2  
 Light Distribution: Adjustable / Asymmetric  
 Weight (kg): 0.473  
 Weight (lbs): 1.04  
 Fixture Finish: SSR / BKV / CWI / CRY / HAB / UFT / ITA / RUA / FTG / MYG / LOD / PUS / FRO / FUP / KIA / POP / BLS / SPG / MEY / GOH / GUM / CHC / COM / ABZ / JAG / OBR / MOS / ROR  
 Fixture Material: Aluminum Die Cast  
 Cut-out Measurements: 98mm / 3 7/8"

### ELECTRICAL

Lamp Type: LED (Zhaga Standard)  
 Input Wattage (W): 16.5  
 Total Output Wattage (W): 14  
 Dimming: Tri-Mode (Non-Dimming and Phase Dimming (120Vac only) and 0-10V Dimming)  
 Driver Included: No  
 Driver Location: Recessed Housing  
 Driver Type: Constant Current - Universal  
 Driver Class: Class 2  
 Housing: See components  
 Input Voltage (V): 120 - 277  
 Constant Current (MA): 500

### LED

Number of LEDs: 1  
 Color Temperature (°K): 2700 / 3000 / 3500 / 4000  
 Max. Delivered Lumen (lm): 1100 / 1140 / 1196 / 1220  
 Nominal Lumen (lm): 1386 / 1438 / 1511 / 1542  
 CRI: >90 CRI  
 Lamp Life (hrs): 50000

### OPTICAL

Reflector: 20 / 40 / 60

### RATINGS AND CERTIFICATIONS

Certified By: Certified for North American Standards  
 IP rating: IP20

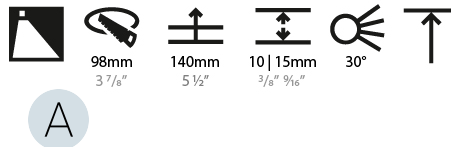

## BIONIQ ROUND WALLWASH RECESSED

A35347-

PROJECT

TYPE

SPECIFIER

QUANTITY

DATE



## BIONIQ ROUND PINHOLE RECESSED

**A37861-** \_\_\_\_\_

base number    Color \_\_\_\_\_    Finishes \_\_\_\_\_  
 Temperature    (Diamond)

- To build a product code in our configurator select the specify button on the base model # product page
- To build a manual product code on this datasheet choose from the options listed below in blue font and add the suffix to the base model #

### GENERAL

Series: Bioniq  
 Subseries: Bioniq Round Pinhole  
 Brand: Prolicht  
 Division: Architectural  
 Mounting Type: Recessed  
 Mounting Location: Ceiling  
 Subcategory: Downlight

### PHYSICAL

Shape: Round  
 Diameter (mm): 107  
 Diameter (in): 4 3/16  
 Height (mm): 112  
 Height (in): 4 7/16  
 Ceiling Thickness (mm): 10 / 12.5 / 15  
 Ceiling Thickness (in): 3/8 or 1/2 or 9/16  
 Min. Recessing Depth (mm): 130  
 Min. Recessing Depth (in): 5 1/8  
 Light Distribution: Adjustable / Downlight  
 Weight (kg): 0.473  
 Weight (lbs): 1.04  
 Fixture Finish: SSR / BKV / CWI / CRY / HAB / UFT / ITA / RUA / FTG / MYG / LOD / PUS / FRO / FUP / KIA / POP / BLS / SPG / MEY / GOH / GUM / CHC / COM / ABZ / JAG / OBR / MOS / ROR  
 Fixture Material: Aluminum Die Cast  
 Cut-out Measurements: 98mm / 3 7/8"

### ELECTRICAL

Lamp Type: LED  
 Input Wattage (W): 13.2 / 16.5  
 Total Output Wattage (W): 12 / 15  
 Dimming: Tri-Mode (Non-Dimming and Phase Dimming (120Vac only) and 0-10V Dimming)  
 Driver Included: No  
 Driver Location: Recessed Housing  
 Driver Type: Constant Current - Universal  
 Housing: See components  
 Input Voltage (V): 120 - 277  
 Constant Current (MA): 350

### LED

Number of LEDs: 1  
 Color Temperature (°K): 2700 / 3000 / 3500 / 4000  
 Max. Delivered Lumen (lm): 850 / 950 / 1019 / 1040  
 Nominal Lumen (lm): 960 / 1070 / 1156 / 1180  
 CRI: >90 CRI  
 Lamp Life (hrs): 50000

### OPTICAL

Reflector°: 10  
 Adjustability: Rotational 355°; Tilt 30°

### RATINGS AND CERTIFICATIONS

Certified By: Certified for North American Standards  
 IP rating: IP20

PROJECT	_____
TYPE	_____
SPECIFIER	_____
QUANTITY	_____
DATE	_____

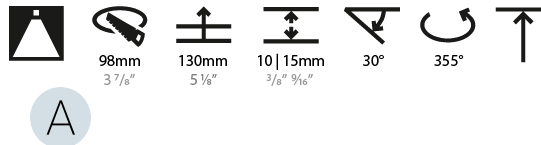

## BIONIQ ROUND PINHOLE RECESSED

A37861-

PROJECT

TYPE

SPECIFIER

QUANTITY

DATE





PROJECT
TYPE
SPECIFIER
QUANTITY
DATE

### Fixture Finish



**Digital:** Not all screens are calibrated the same, and therefore, colors will appear differently between screens.

**Physical:** When texture is involved, there will be variations in color, character and tone within a product series and between product families.

**Gun Metal:** No Gun Metal finish is alike. It combines a mixture of transparent and black color particles which ensures a highly individual effect and no luminaire being identical.

**Champagne Cream, Copper Mine, Ancient Bronze + Jazz Gold:** These finishes have slight fading from specific powder coating production. Each luminaire will slightly vary.













### LEGEND

 floor-mounted	 pivotable	 special LED (upon request) RGB, RGBW, tunable, gold+, meat+, art+, fashion+
 wall and ceiling: recessed and surface mounted	 rotating	 warm dim / natural dimming LED
 ceiling-mounted and wall-mounted	 illuminate tilted	 rechargeable battery powered
 wall-mounted	 color of suspension cable	 fixture with natural vivid LED (upon request)
 omni-directional light distribution	 length of suspension cable	 color rendering index
 direct light distribution	 reflector degree selection	 color temperature
 direct/indirect light distribution	 super spot	 lumen (luminous flux)
 indirect light distribution	 lens	 efficacy (lumens per watt)
 asymmetric light distribution	 lens pack	 Unified Glare Rating (UGR) range from 5-40
 aura light distribution	 shine ring	 marine grade (AISI 316 stainless steel)
 round wall or ceiling cut-out	 integrated shine ring with diffuser	 walk on
 square wall or ceiling cut-out	 free individual colors 01-29	 drive on
 the supplied jig specifies the cutout dimensions	 individual colors: 00 (free of charge), 01-25 (extra charge)	 Dark Sky Compliance
 minimum distance (meters) lamp - object	 luminaire part to be colored (F1)	 Americans with Disabilities Act (less than 4" off the wall located between 27"-84" from floor)
 recessed depth	 luminaire part to be colored (F2)	 lamp protected against explosion
 ceiling thickness in mm	 luminaire part to be colored (F3)	 blown glass using traditional methods by master glass blower
 ceiling thickness selection	 luminaire part to be colored (F4)	 acoustic material
 dimmable DP (phase), DV (0-10V), DD (dali), DS (step-dim)	 luminaire part to be colored (F5)	 protection class I, protection insulation
 included or excluded LED driver/transformer/control gear	 color of 3-circuit adaptor	 protection class II, protection insulation
 separately switchable	 indirect diffuser	 ETL Certified to UL and CSA Standards
 sensor	 direct diffuser	 UL Certified to UL and CSA Standards
 remote control	 ball-proof (upon request)	 CSA Certified to UL and CSA Standards
 available upon request	 accessory	 Certified for North American Standards

### IP RATING

 IP20	protected against ingress of solid bodies greater than 12.5mm (finger)
 IP33	protected against ingress of solid bodies greater than 2.5mm protected against sprays of water up to 60 degrees from the vertical (rain)
 IP40	protected against ingress of solid bodies greater than 1mm (wire) no protection against the ingress of moisture
 IP43	protected against ingress of solid bodies greater than 1mm (wire) protected against sprays of water up to 60 degrees from the vertical (rain)
 IP44	protected against ingress of solid bodies greater than 1mm (wire) protected against water splashed from all directions
 IP54	protected against limited ingress of dust (wet rooms/covered outdoor areas) protected against water splashed from all directions
 IP65	protected against ingress of dust protected against jets of water
 IP66	protected against ingress of dust protected against powerful jets of water or heavy seas
 IP67	protected against ingress of dust protected against immersion of water between 15cm - 1m for 30 minutes
 IP68	protected against ingress of dust protected against immersion of water under pressure for long periods

### IK RATING

 IK01	protected against 0.14 joules impact (equivalent to 0.25kg mass dropped from 56mm above the surface)
 IK02	protected against 0.2 joules impact (equivalent to 0.25kg mass dropped from 80mm above the surface)
 IK03	protected against 0.35 joules impact (equivalent to 0.25kg mass dropped from 140mm above the surface)
 IK04	protected against 0.5 joules impact (equivalent to 0.25kg mass dropped from 200mm above the surface)
 IK05	protected against 0.7 joules impact (equivalent to 0.25kg mass dropped from 280mm above the surface)
 IK06	protected against 1 joules impact (equivalent to 0.25kg mass dropped from 400mm above the surface)
 IK07	protected against 2 joules impact (equivalent to 0.5kg mass dropped from 400mm above the surface)
 IK08	protected against 5 joules impact (equivalent to 1.7kg mass dropped from 300mm above the surface)
 IK09	protected against 10 joules impact (equivalent to 5.0kg mass dropped from 200mm above the surface)
 IK10	protected against 20 joules impact (equivalent to 5.0kg mass dropped from 400mm above the surface)